

EFFEKTIV DATAFLYT FRA DRØM TIL VIRKELIGHET

KRISTINA AALVIK & FRODE VATNE

DATE 26.11.2023



PELAGIA™

Effektiv dataflyt, fra drøm til virkelighet

Pelagia, en av verdens største fiskeforedlingsbedrifter, har tatt i bruk D365 FO og økosystemet til Microsoft.

- Først var det å ta i bruk D365 på alle prosesser med PowerApps og PowerPages som front end, deretter ved å bruke flow og integrasjoner for å automatisere.
- Visualisering ved hjelp av PowerBI, Azure digital twin og selvfølgelig hva er en drøm uten litt AI for å formidle kunnskapen? Alle buzz ordene brukt i virkeligheten for å skap fremtiden.

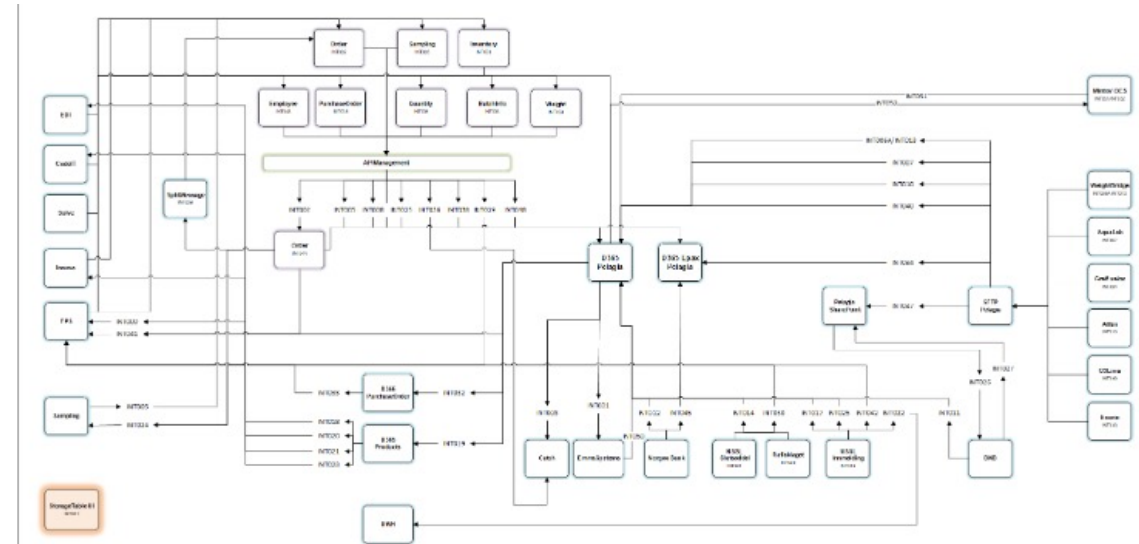

[PelagiaOverview.vsd](#)

In the picture above you see the integrations with SLA C1 marked in Blue.



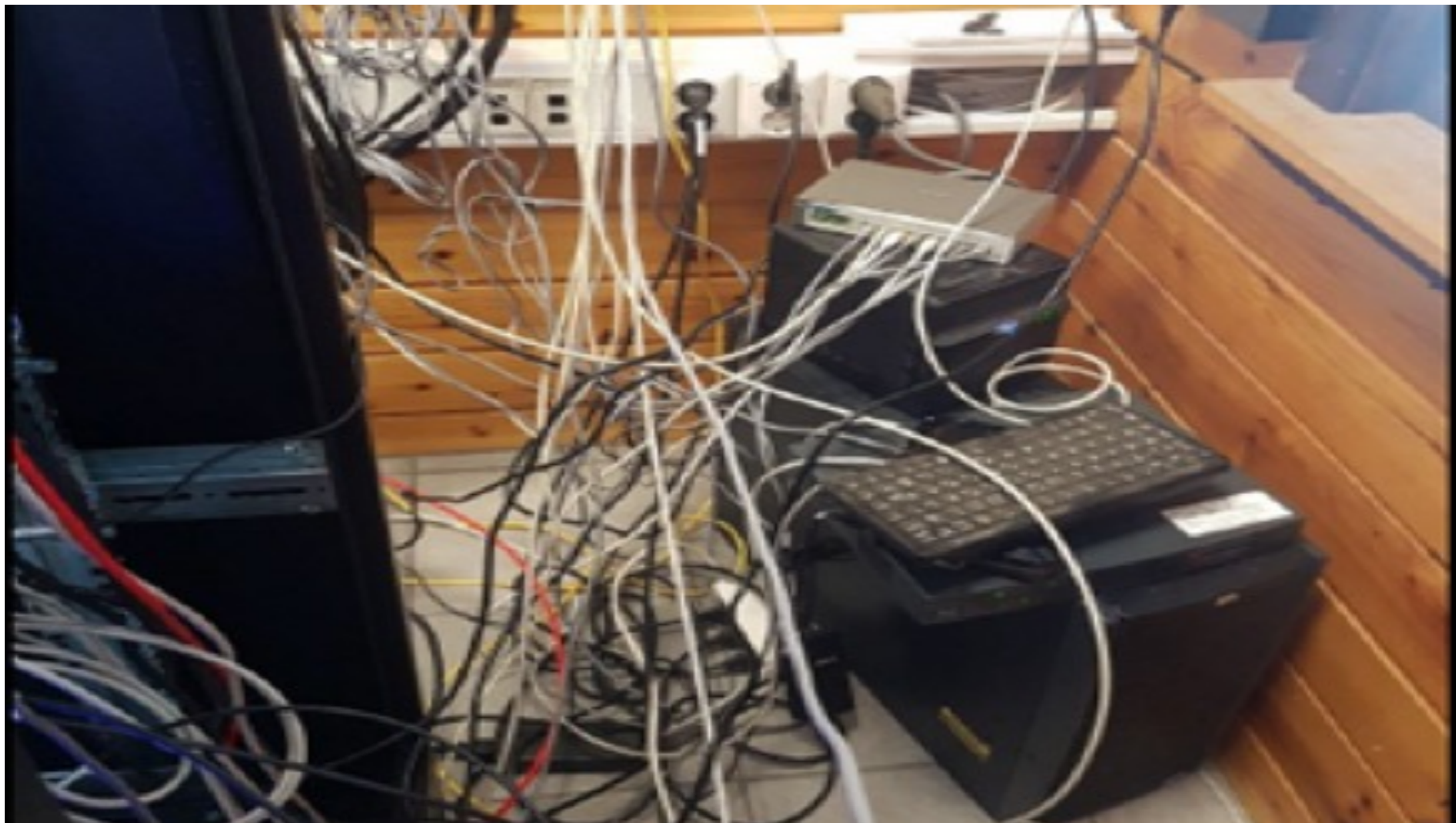



This Photo by Unknown Author is licensed under [CC](#)

IT focus areas (Drømmen skapes i mars 2017)

Transactions

The correct information is delivered at the right time and produced with minimal resource usage.

Efficiency

With IT tools and methodology, we will reduce manual work as much as possible.

Knowledge

Through the use of analysis and AI, we aim to predict future needs and produce customer-focused products.



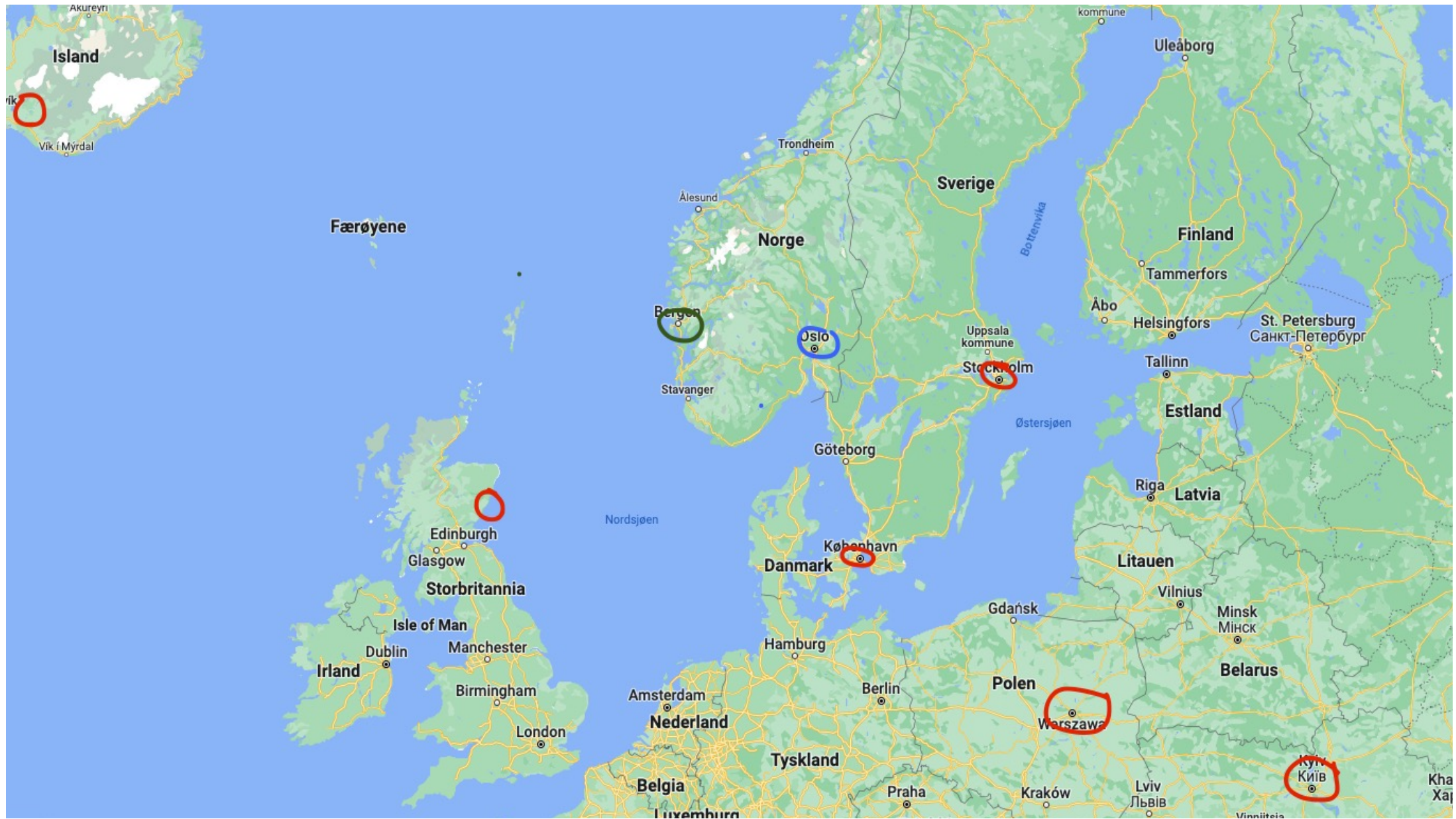



DRØM

LEK

UTFORSK

Identity management

The aim of the project

Automate

Automate user access, based on place and function. Ensure that all employees and IOT have correct access with minimum human intervention to give and revoke access/privileges.

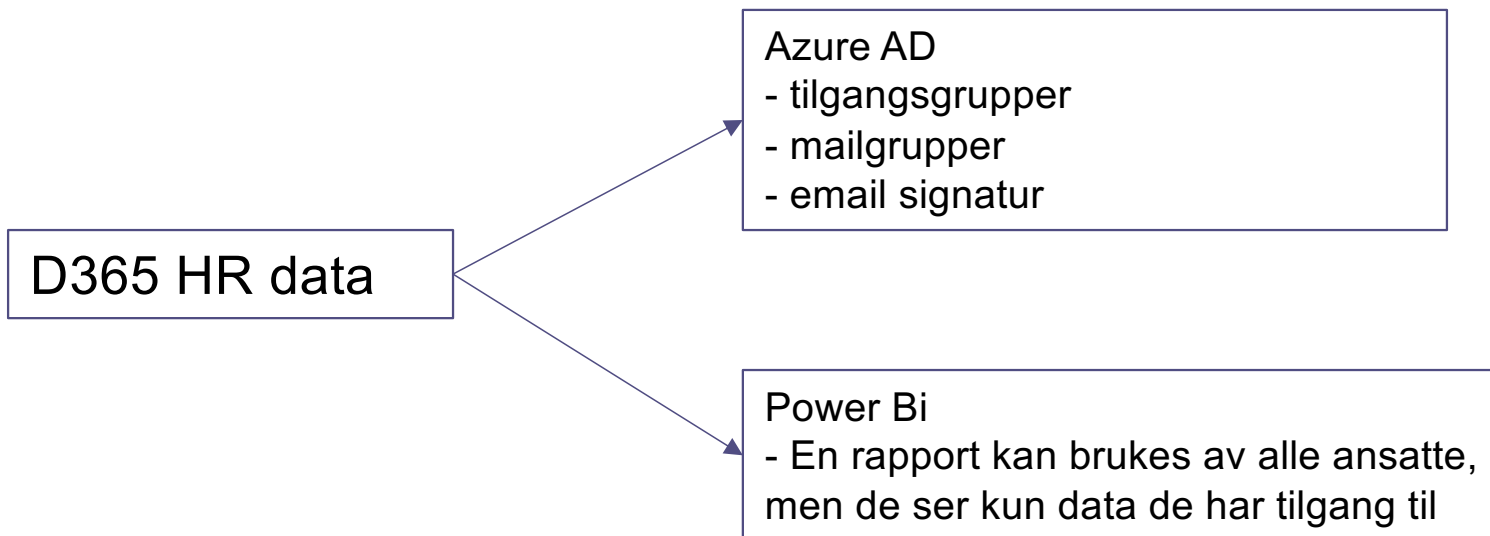

Standardisert på et økosystem - Microsoft

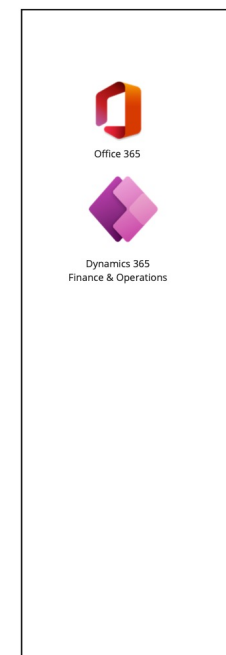
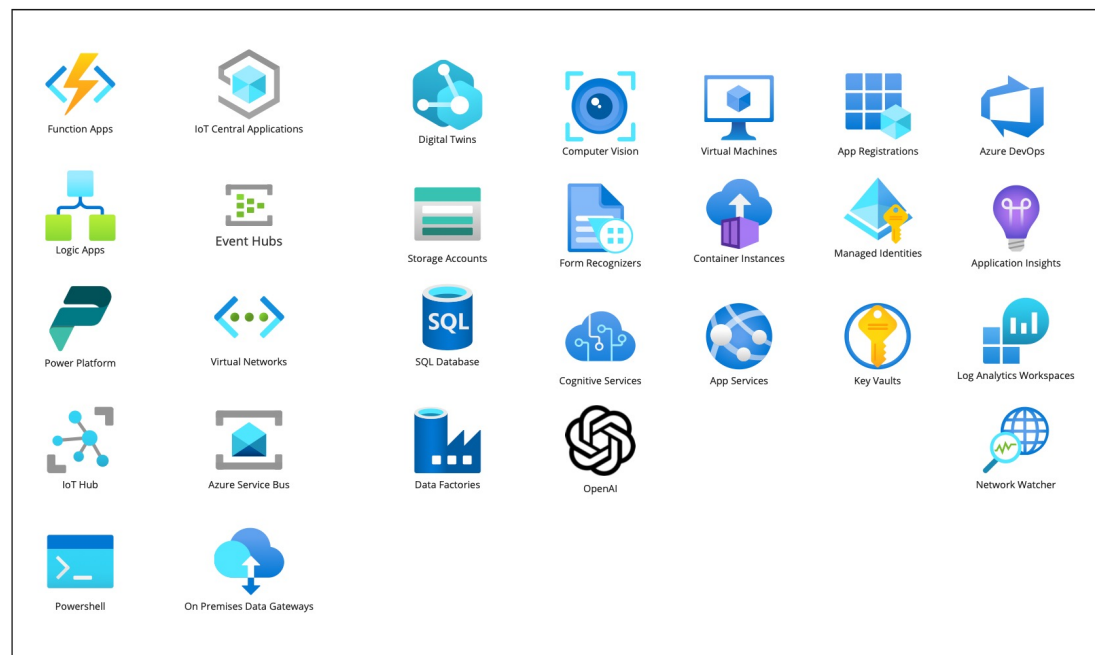
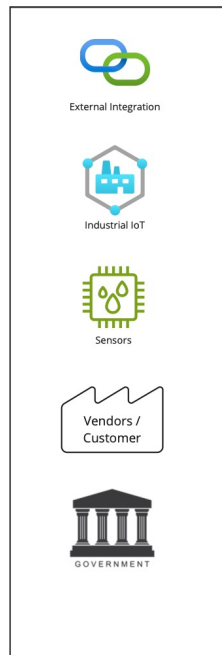
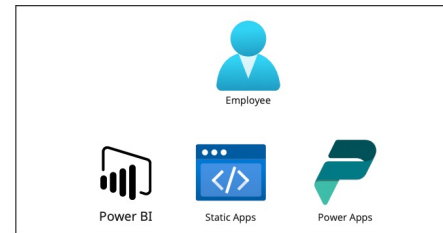
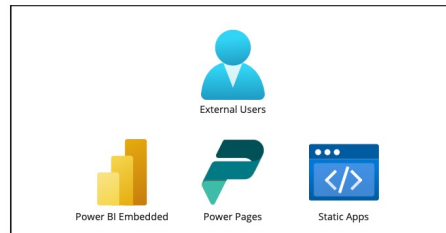





BILDER



Регистрационный номер: 87701.R.R.N.A
Судно: Мона / Моня / 柳叶魚
Формат упаковки: замороженные / 凍肉
Round / Размораживание: не требуется / 無需
Net weight: 20 kg / 淨重: 20 公斤
230220 22774
Vessel: Ray
Vessel Code: FAO 27
Catch date: 07.02
Freezing date: 20.02.2023
MS-C-50933
Содержит консерванты / 含有防腐劑
Preparation: frozen -18°C
MS-C-50933
N1036
EFTA

On-hand

My view * ∨

∨

Product name	Search name	Site	Warehouse	∨ Batch number
Discards Baltic (Pommetus vitreus)	DISC BALTIC	MaaloFoo	MaaloFoo	231103 133233
CAP IS 25-35 male Round 20kg FG	CAP IS 25-35 WR ...	MaaloFoo	MaaloFoo	3136223

[Open folder](#)

[Send email](#)



IMG_7268
August 31, 2023 1:45 PM
3136223

[Open](#)

Attach



IMG_7266
August 31, 2023 9:10 PM
3136223

[Open](#)

Attach

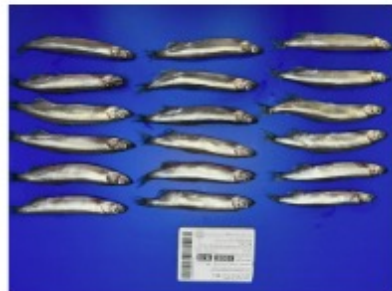

IMG_7269
August 31, 2023 1:45 PM
3136223

[Open](#)

Attach



LOGISTIKK

Case

7 transportbåter som skal hente fiskeavskjær på 900+ lokasjoner

- Uforutsigbarhet
- Innkjøp
- Salg
- Mellomfrakt



Tablett for visning og registrering av innkjøp, salg og flytte ordrer



Utskrift og mail for diverse dokumenter



Azure digital twin



PowerBI



Hordafor Pickup

Close Current Voyage



HordIV



View Purchase Orders

View Sales Orders

View Transfer Orders

All Orders

PO047271

HordIV

Order Type	Purchase	Vendor	Cermaq Norway AS
Registered Date	10.11.2023	Location	YTRE KOVEN 32617
Deadline Pickup	10.11.2023	Info to transporter	46807553 Eilif Johansen



540506

HordIV

Order Type	Sale	Customer	Salmar Farming AS
Registered Date	09.11.2023	Location	LANGNESET 45154
Deadline Pickup	09.11.2023	Info to transporter	483 60 143 Alwin



Refresh

Gå til lossing

New Order



Purchase Order PO047271



Vendor

Name: Cermaq Norway AS
 Registered Date: 10.11.2023
 Deadline pick up date: 10.11.2023
 Remark:

Vendor Location

Location Name:
 Location No.: 000068818
 GPS Coordinates: 22,892567 70,142117

Important Information

Sickness: No
 Medical Restriction: No
 Medical Information:
 Info from transporter:
 Info to transporter: 46807553 Eilif Johansen

Receiving Warehouse

Warehouse Name:
 Warehouse No.:

Contact Transporter

Transporter Name:

Vendor Signature

Contact Name:
 Email:
 Phone:

Order Lines

Product	Quantity	Unit	Tank Location Vessel	PH Value	Smell
Cat.3 Salmon Silage	210000	kg	<input type="text" value="SB1"/>	<input type="text" value="3"/>	<input type="text" value="1 - Normal odour"/>



UAT

Document Signatures



Signature for Boat:

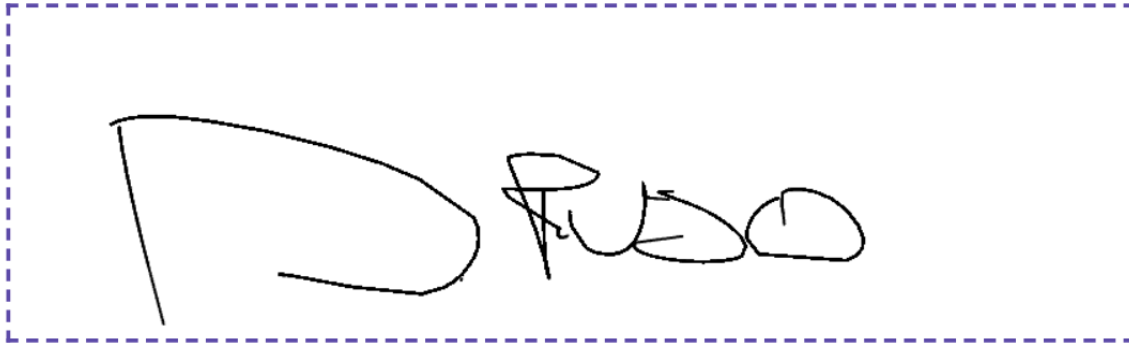

Signature for Vendor:

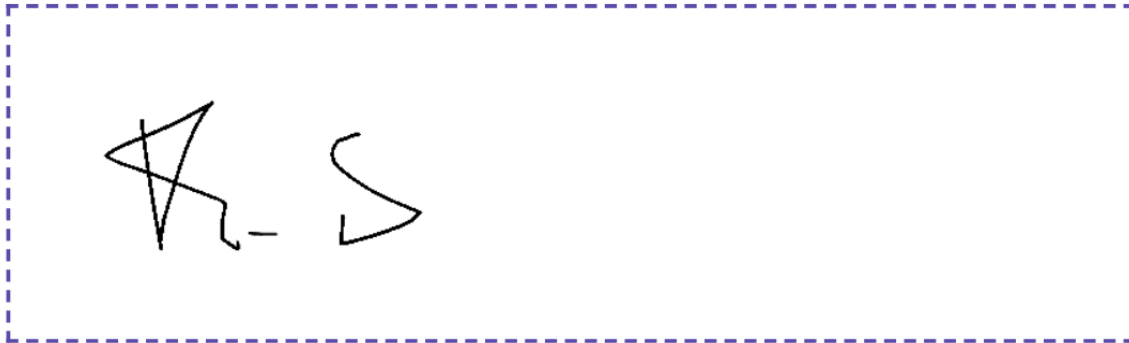

Finish

HANDELSDOKUMENT

For transport av animalske biprodukter og avledede produkter som ikke er beregnet for humant konsum i henhold til animalskproduktforskriften i samsvar med forordning (EF) nr. 1069/2009

Dokument nr.: PO045160-K3 Dato: 16.10.2023

AVSENDER
Navn: Austevoll Laksepakkeri AS Biproduktnummer: 19519
Adresse: 5392 STOREBØ
Poststed: 5392 STOREBØ
Lokalitet: STOREBØ

MOTTAKER
Navn: Pelagia avd. Averøy Biproduktnummer: 120097
Adresse: Hasløyveien 224
Poststed: 6533 AVERØY

TRANSPORTØR
Navn: M/S Hordafor III
Adresse: Bradbenken 1
Poststed: 5003 BERGEN

Transportmiddel: M/S Hordafor III Biproduktnummer: 1001547



Beskrivelse av animalsk biprodukt:

Type råstoff	Antall	Enhet	Målt ved henting	
			pH	Lukt
Cat.3 Salmon Silage	210000	kg	3	1 - Normal odour

Kategori 3-Bokstav i artikkel 10 EC 1069/2009: J

Tilleggsinformasjon:

Kim Sæbø
(for avsender)

Daniel Rusu
(for transportør)

Til avsender, transportør og mottaker: Dette er minimumskrav til informasjon i handelsdokumenter for biprodukter innenlands. Handelsdokumentet eller dets elektroniske versjon, skal følge biproduktene fra avsender til mottaker. Avsender skal fylle ut og signere handelsdokumentet slik at originalen følger forsendelsen. Både avsender og transportør beholder kopi.

Utvikle version 2

Automatisere

Geofencing

ESG
informasjon

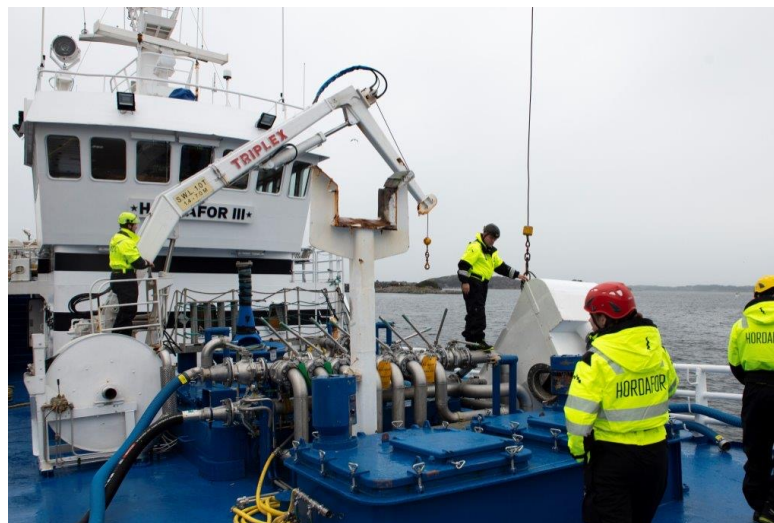



POWER PAGES



PELAGIA™

Welcome to Pelagia AS partner portal

Which portal do you want to access?

Pickup

Employee

Hi, Kristina!

Request a new order >

Norway AS

Home

Documentation

Order History

Sustainability

Quality

Support

Quantity (Last 30 days)

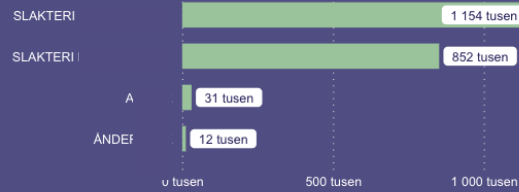

Pick Up Locations (Last 30 days)



Orders (Last 30 days)

Date	Order ID	Order Status	Location	Item	Vessel	Quantity	Unit
16-10-2023	PO045696	Open Order	SLA	Cat.3 Salmon Silage	M/S Hordafor IV		kg
15-10-2023	PO045695	Received	ANI	Cat.2 Silage	Pelagia Hordafor		kg
11-10-2023	PO045376	Received	ANI	Cat.2 Silage	Pelagia Hordafor		kg
11-10-2023	PO045317	Received	SLA	Cat.3 Salmon Silage	Pelagia Hordafor		kg
10-10-2023	PO045233	Received	SLA	Cat.3 Salmon Silage	M/S Hordafor IV		kg
10-10-2023	PO045411	Open Order	SLA	Cat.2 Silage	M/S Hordafor IV		kg
04-10-2023	PO044727	Received	SLA	Cat.3 Salmon Silage	M/S Hordafor IV		kg
04-10-2023	PO045027	Open Order	SLA	Cat.2 Silage	M/S Hordafor IV		kg
02-10-2023	PO044728	Received	SLA	Cat.3 Salmon Silage	Pelagia Hordafor		kg
02-10-2023	PO044894	Received	SLA	Cat.2 Silage	Pelagia Hordafor		kg
Totall							



DIGITAL TWIN



JOEVRM-OIL-8

State All properties

Level

Fill level
73.3%

A digital gauge interface for 'JOEVRM-OIL-8'. It features a 'Level' section with a 'Fill level' of 73.3%. Below the text is a semi-circular gauge with a needle pointing to the 73.3% mark. The gauge has a color gradient from green on the left to red on the right.



PELAGIA Lager råvare Hordafor VII

PO lager	105176 Cat.3 Salmon Silage	105179 Cat.2 Silage	Total
M/S Hordafor VII	278,000	468,000	746,000
Total	278,000	468,000	746,000

PO status 2	Total
Total	

TO Lager	105176 Cat.3 Salmon Silage	105179 Cat.2 Silage	Total
M/S Hordafor VII	138,000	773,500	911,500
Total	138,000	773,500	911,500

Volum pr. produkt

A stacked bar chart comparing the volume of two products. The x-axis lists '105179 Cat.2 Silage' and '105176 Cat.3 Salmon Silage'. The y-axis represents volume. The bars are stacked with Hordafor VII PO (purple) at the bottom and Hordafor VII TO (green) on top. The total volume for each product is shown above the bars.

Product	Hordafor VII PO	Hordafor VII TO	Total
105179 Cat.2 Silage	468,000	773,500	1,241,500
105176 Cat.3 Salmon Silage	278,000	138,000	416,000





GPT BOT

Ask anything or try an example in your preferred language

Hvordan utføre en
lagerflytting?



Hvilken fraværskode har
ferie?



Hvilke steg må gjøres for
en partisammenslåing?



Type a new question



Hvordan legger jeg til en MarinTrust-attributt på en batch?



For å legge til en MarinTrust-attributt på en batch i Microsoft Dynamics 365, følg disse trinnene:

1. Finn frem den aktuelle batchen under «Batches» eller «On-hand list» ^{1. page 3}.
2. Marker batchen i listen, eller klikk helt inn på batchen, og klikk så «View» + «Stock batch attributes» ^{1. page 3}.
3. Marker MarinTrust i attributt-listen, og velg «Yes» eller «No» i nedtrekksmenyen under «Attribute values» ^{1. page 4}.
4. Klikk «Save» ^{1. page 4}.
5. Hvis ikke MarinTrust attributten allerede ligger i listen over attributter velg «+New» og legg så til MarinTrust som attributt ^{1. page 4}.
6. Legg så til «Yes» eller «No» under «Attribute value». Klikk så «Save» ^{1. page 4}.

Citations: [1. MarinTrust på partier](#)

Follow-up questions: [Hvordan kontrollerer jeg MarinTrust-attributt på en batchmerge og dens delpartier?](#)

[Hva gjør jeg hvis MarinTrust-attributt ikke vises i listen?](#)

[Hvordan legger jeg til en ny attributt hvis den ikke allerede er i listen?](#)

Retry

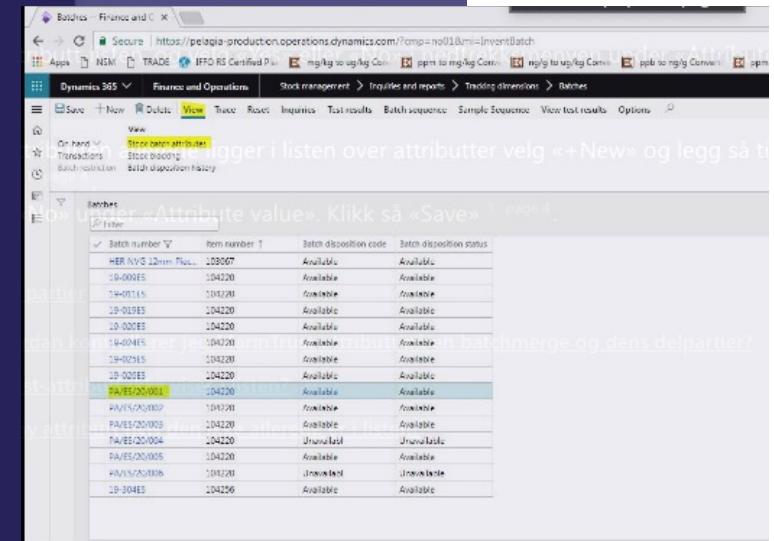

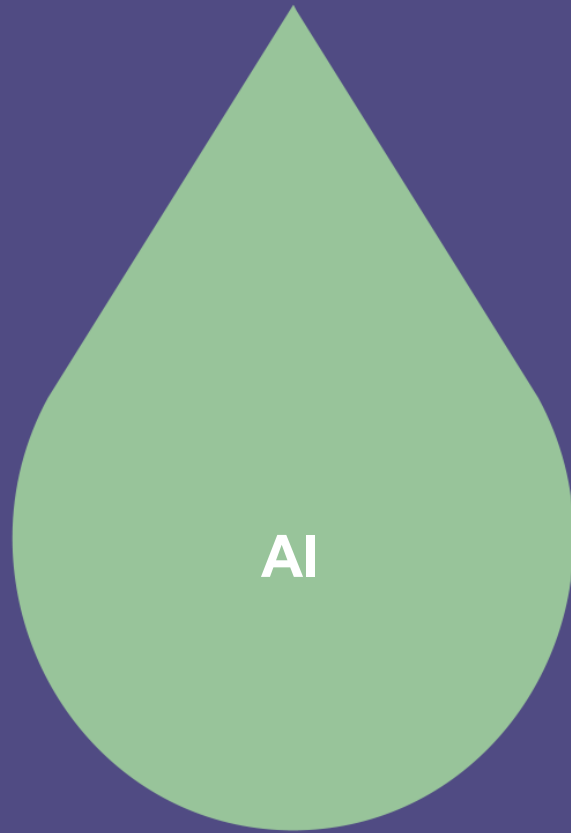

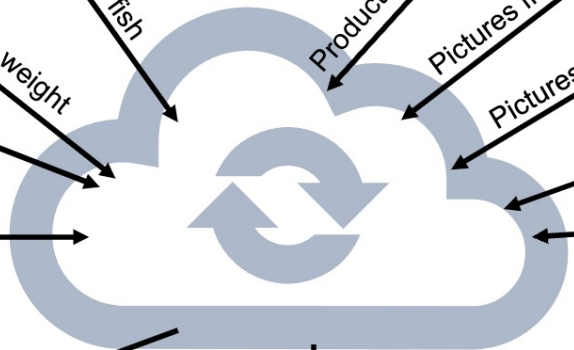
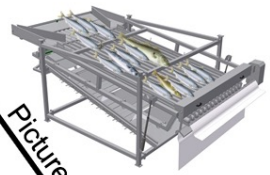
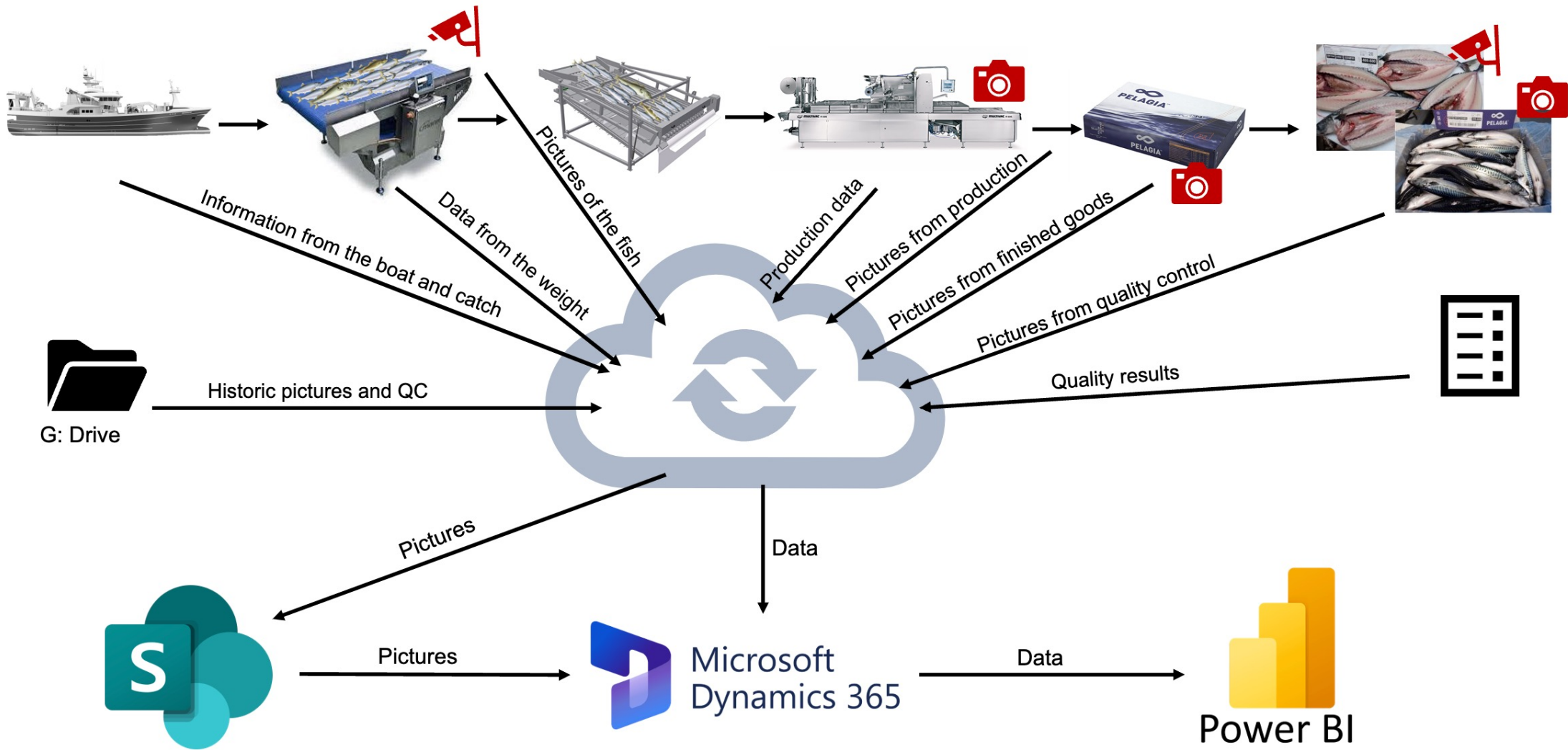

G: Drive



Microsoft Dynamics 365



Hvordan er dette mulig?

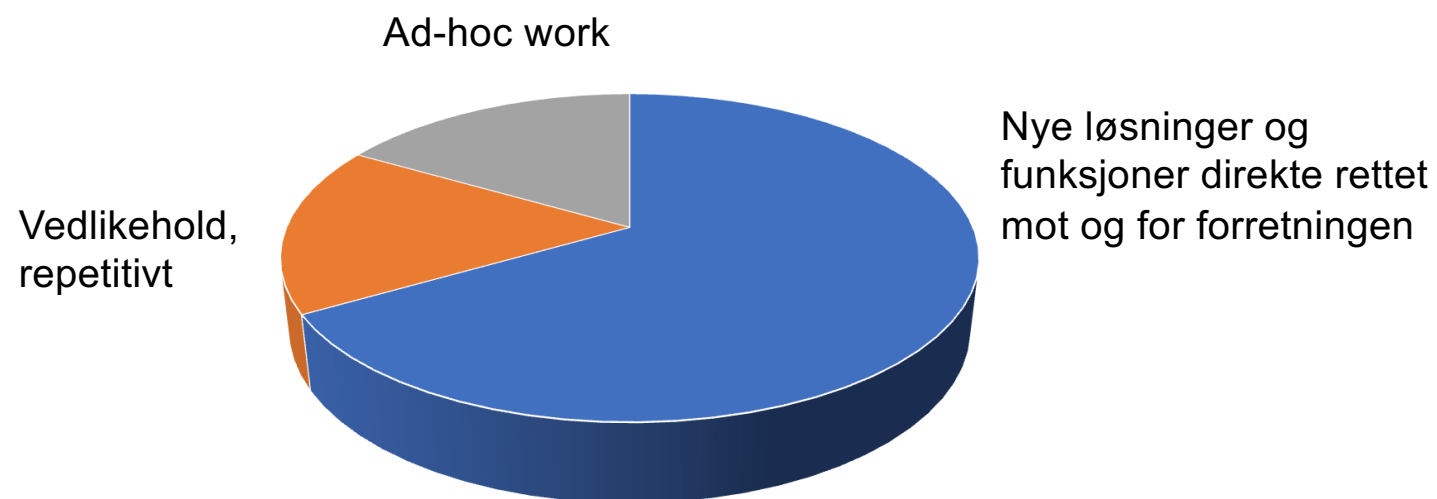

Takk for oss



Det som er godt nok i dag er ikke godt nok i morgen!

Heldigvis kommer utviklingen aldri til å gå så sent som den gjør i dag i fremtiden